



VENTIS

The perfect match

between wood appliances and venting products

occnada.com

Stoves + Inserts + Fireplaces



OLYMPIA

OLYMPIA CHIMNEY
OF CANADA Inc.
"Your Partner in the Business"

CHEMINÉES OLYMPIA
DU CANADA inc.
"Votre partenaire en affaires"





MAX

Maximum heat output BTU/h (dry cordwood)



Recommended heating area (ft²)



Firebox volume (ft³)



Average particulate emissions rate (g/h)



Maximum log length (in.)

WOOD FIREPLACES

HE250R	4
HE275CF	6
HE325	8
HE350	10
ME150	12
ME300	14

WOOD STOVES

HES140	16
HES170	17
HES240	18
HES350	19

WOOD INSERTS

HEI90	20
HEI170	21
HEI240	22
HEI350	23

TECHNICAL DATA 24

Images presented in this catalog are for reference only. Some changes may have been made to the products or technical data after the publication of this brochure. Olympia Chimney of Canada reserves the right to modify their products without any obligation on its part. Any installation must be done according to the data and drawings detailed in the owner's manual.

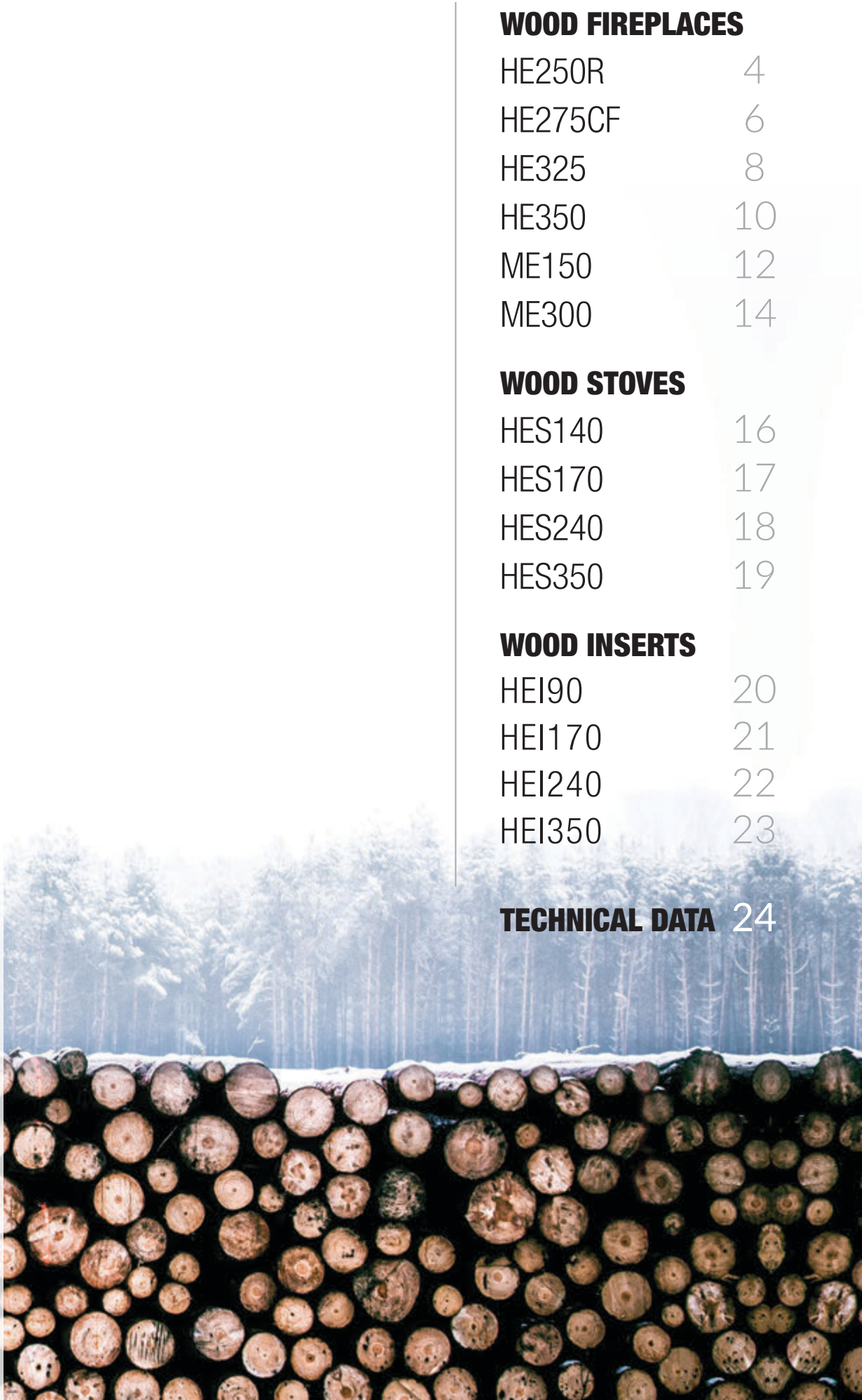

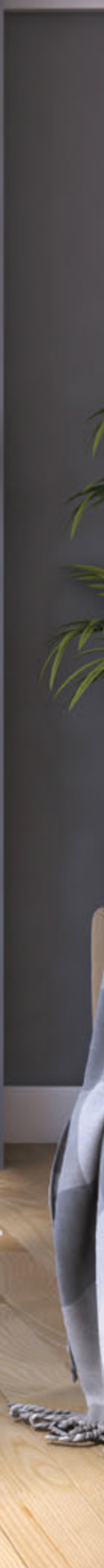



80,000 BTU/h



750 - 2,200 ft²



2.5 ft³



1.2 g/h



20"

HE250R

MANUFACTURER CODE VB00015

EPA



INCLUDED

- Designed mainly for heating
- Large, classic fireplace with single door
- Non-catalytic combustion technology
- Ventis distinctive louvers
- Durable C-Cast baffle
- Moulded refractory bricks
- 6" Ventis stainless steel anchor plate included
- Fresh air intake adapter included

Required accessory

VBA1560 Black modern faceplate

Options

AC01223 Heat shield for shelf/mantel
 AC01275 Firescreen door
 AC01347 4"Ø fresh air intake register with airtight damper
 AC01375 Hot air gravity kit - traditional
 AC01389 Hot air gravity kit - modern with adjustable pipes
 AC09200 Carrying handles
 AC01374 Forced air kit
 AC01350 6"Ø X 25' insulated flex pipe for forced air kit

HE275CF

MANUFACTURER CODE VB00017

EPA



HOT AIR GRAVITY KIT MODERN WITH ADJUSTABLE PIPES



HOT AIR GRAVITY KIT TRADITIONAL

- Designed mainly for heating
- Large, contemporary fireplace with single door
- Non-catalytic combustion technology
- Ventis minimalist distinctive louver
- Durable C-Cast baffle
- Moulded refractory bricks
- 6" Ventis stainless steel anchor plate included
- Fresh air intake adapter included

Required accessories

AC01389K Hot air gravity kit – modern with adjustable pipes
or

AC01375K Hot air gravity kit – traditional

Options

- AC01275 Firescreen door
- AC01347 4"Ø fresh air intake register with airtight damper
- AC09200 Carrying handles
- AC01363 Forced air kit
- AC01350 6"Ø X 25' insulated flex pipe for forced air kit



80,000 BTU/h



750 - 2,200 ft²



2.5 ft³



1.2 g/h



20"



HE325

MANUFACTURER CODE VB00018

EPA



DISTINCTIVE LOUVERS



INCLUDED

- Designed mainly for heating
- Large, high-efficiency fireplace among the most powerful on the market
- Retractable double doors for an unrivaled experience
- Non-catalytic combustion technology
- Ventis distinctive louvers
- Durable C-Cast baffle
- 6" Ventis stainless steel anchor plate included
- Fresh air intake adapter included

Required accessory

VBA1570 Black modern faceplate

Options

AC01347 4"Ø fresh air intake register with airtight damper
 AC01375 Hot air gravity kit - traditional
 AC01379 Firescreen door
 AC09200 Carrying handles
 VA4460 Forced air kit
 AC01350 6"Ø X 25' insulated flex pipe for forced air kit



MAX

85,000 BTU/h



750 - 2,500 ft²



3.0 ft³



0.99 g/h



18"





**PATENTED
APPLIANCE**





MAX

95,000 BTU/h

1,000 - 2,800 ft²4.28 ft³

1.6 g/h



25"

HE350

MANUFACTURER CODE VB00005

EPA



INCLUDED

- Designed mainly for heating large spaces
- Patented design of the intelligent air control mechanism
- Luxurious effect created by an eye-catching fireplace
- Large glass surface
- Non-catalytic combustion technology
- Durable C-Cast baffle
- 8" Ventis stainless steel anchor plate included
- Fresh air intake adapter included

Required accessories

VBA1540 Black traditional faceplate

AC02360 Classic moulded refractory brick panels

Options

AC01349 5"Ø fresh air intake register with airtight damper

AC01378 Warm air circulation grille - modern style

AC09200 Carrying handles

VA4460 Forced air kit

ME150

MANUFACTURER CODE VB00004

This appliance is
**EPA
exempt**



FACTORY-INSTALLED DOORS AND FACEPLATE

- Designed mainly for ambiance
- Generates enough heat in the event of a power failure
- Premium manufacturing quality
- Moulded refractory bricks
- Firescreen doors included
- Cast iron reclining grate
- 7" Ventis stainless steel anchor plate included
- Fresh air intake adapter included

Options

AC01347 4"Ø fresh air intake register with airtight damper
VA4400 Blower with variable speed control





ME300

MANUFACTURER CODE VB00001

This model is
EPA QUALIFIED
 Under the LOW MASS
 Wood-Burning Fireplace Program

PHASE 2
 EMISSION LEVEL



HOT AIR GRAVITY KIT MODERN



HOT AIR GRAVITY KIT TRADITIONAL



- Large fireplace designed mainly for ambiance
- Generates enough heat in the event of a power failure
- Incomparable view on the flames
- Moulded refractory bricks
- Firescreen doors included
- 8" Ventis stainless steel anchor plate included
- Fresh air intake adapter included

Required accessory

VBA1520 Black traditional faceplate

Options

AC01340 Forced air kit
 AC01347 4"Ø fresh air intake register with airtight damper
 AC01375 Hot air gravity kit – traditional
 AC01376 Hot air gravity kit – modern
 AC01350 6"Ø X 25' insulated flex pipe for forced air kit



< 1,500 ft²



4.25 ft³



20"







HES140

MANUFACTURER CODE VB00023



MAX

45,000 BTU/h



250 - 1,200 ft²



1.7 ft³



1.8 g/h



17"

- Small wood stove on pedestal
- Solidity and manufacturing quality
- Non-catalytic combustion technology
- Installation authorized on the Island of Montreal
- Cast iron door
- Top heat deflector and side panels

Options

AC02023
Blower
(thermodisque inclus)

AC01420
Rigid firescreen

AC01336
5"Ø fresh air intake kit

HES170

EPA

MANUFACTURER CODE VB00013



MAX

65,000 BTU/h

500 - 1,800 ft²1.86 ft³

2.4 g/h



18"

- Medium size wood stove on pedestal suitable for smaller spaces
- Premium manufacturing quality
- Non-catalytic combustion technology
- Cast iron door
- Top heat deflector and side shields

Options

AC01000
130 CFM blower with variable speed control (thermodisc included)

AC01299
Rigid firescreen

AC01336
5"Ø fresh air intake kit





HES240

MANUFACTURER CODE VB00016



MAX

75,000 BTU/h



500 - 2,100 pi²



2.4 pi³



2.3 g/h



20"

- Large wood stove on pedestal
- Premium manufacturing quality
- Non-catalytic combustion technology
- Cast iron door
- Top heat deflector and side shields

Options

AC01000
130 CFM blower with variable speed control (thermodisc included)

AC01315
Rigid firescreen

AC01336
5"Ø fresh air intake kit

HES350

EPA

MANUFACTURER CODE VB00020



MAX

110,000 BTU/h

1,000 - 2,700 ft²3.5 ft³

1.6 g/h



22"

- Extra-large wood stove on pedestal
- Solidity and manufacturing quality
- Non-catalytic combustion technology
- Installation authorized on the Island of Montreal
- Cast iron door
- Top heat deflector and side panels

Options

AC01000
130 CFM blower with variable speed control (thermodisc included)

AC01281
Rigid firescreen

AC01336
5"Ø fresh air intake kit





HEI90

MANUFACTURER CODE VB00024



MAX

45,000 BTU/h



250 - 1,200 ft²



1.1 ft³



1.5 g/h



17"



INCLUDED

- Small appliance suitable for smaller spaces
- Premium manufacturing quality
- Non-catalytic combustion technology
- Cast iron door

Required accessories

VBA1545
Regular faceplate 26" x 42"

Options

AC01298
5"Ø fresh air intake kit

AC01213
Firescreen door

AC01214
Liner deviation adapter

AC02006
Hook up liner system

HEI170

 EPA

MANUFACTURER CODE VB00014

INCLUDED

- **Medium appliance suitable for smaller spaces**
- **Premium manufacturing quality**
- **Non-catalytic combustion technology**
- **Cast iron door**

Required accessories

VBA1555
Regular faceplate 29" x 44"
or
VBA1556
Large faceplate 34" x 50"

Options

AC01298
5"Ø fresh air intake kit

AC01299
Rigid firescreen

AC01214
Liner deviation adapter

AC02006
Hook up liner system



MAX

65,000 BTU/h

 500 - 1,800 ft²

 1.86 ft³

2.4 g/h



18"





HEI240

MANUFACTURER CODE VB00012



MAX

75,000 BTU/h



500 - 2,100 ft²



2.4 ft³



2.3 g/h



20"



INCLUDED

- Large appliance
- Premium manufacturing quality
- Non-catalytic combustion technology
- Cast iron door

Required accessories

VBA1550
Regular faceplate 29" x 44"
or
VBA1551
Large faceplate 34" x 50"

Options

AC01298
5"Ø fresh air intake kit

AC01315
Rigid firescreen

AC01214
Liner deviation adapter

AC02006
Hook up liner system

HEI350

 EPA

MANUFACTURER CODE VB00021

INCLUDED

- Extra-large size wood insert
- Solidity and manufacturing quality
- Non-catalytic combustion technology
- Installation authorized on the Island of Montreal
- Cast iron door

Required accessories

VBA1557
Regular faceplate 32" x 44"
or

VBA1558
Large faceplate 34" x 50"

Options

AC01298
5"Ø fresh air intake kit

AC01281
Rigid firescreen

AC01214
Liner deviation adapter

AC02006
Hook up liner system



MAX

110,000 BTU/h

 1,000 - 2,700 ft²

 3.5 ft³

1.6 g/h



22"



WOOD FIREPLACES

ME150
VB00004



ME300
VB00001



HE250R
VB00015



FEATURES

COLOR	Black	Black	Black
BURN TIME (ON LOW SETTING)	N/A	N/A	8 hours
COMBUSTION TECHNOLOGY	Non-catalytic	Non-catalytic	Non-catalytic
HEATING CAPACITY - BTU/h, EPA TEST LOAD	N/A	N/A	60,700
HEATING CAPACITY - BTU/h, SEASONED CORD WOOD	N/A	N/A	80,000
EMISSIONS (EPA)	N/A	2.9 g/kg	1.2 g/h
OPTIMUM EFFICIENCY	N/A	N/A	70%
DOOR OPENING DIMENSIONS (W X H)	28 1/4" x 14 1/2"	30" x 16 1/2"	25 3/8" x 10 9/16"
FIREBOX DIMENSIONS (W X D) BEHIND ANDIRON	19 5/8" x 10 1/8"	23 1/8" x 10 5/8"	20 3/8" x 12 7/8"
GLASS VIEWING AREA (W X H)	28 3/4" x 16 1/2"	28 1/2" x 17 1/8"	24" x 10 5/8"
DOOR TYPE	Double, glass with steel frame	Double, glass with steel frame	Single, glass with cast iron frame
MAXIMUM LOG LENGTH	16"	20"	20"
RECOMMENDED LOG LENGTH	N.A.	N.A.	16"
LOG POSITIONING	Over width	Over width	Over width
CHIMNEY DIAMETER (INNER)	7"	8"	6"
MINIMUM CHIMNEY HEIGHT (FROM BASE OF FIREPLACE)	15'	15'	15'
GLASS TYPE	Ceramic glass	Ceramic glass	Ceramic glass
WARRANTY	Limited lifetime	Limited lifetime	Limited lifetime
TEST STANDARD - EMISSIONS/EFFICIENCY	EPA exempt	ASTM 2515 / ASTM 2558	EPA / CSA B415.1-10
TEST STANDARD - SAFETY	ULC-S610 / UL 127	ULC-S610 / UL 127	ULC-S610 / UL 127

EXTERIOR DIMENSIONS AND WEIGHT

WIDTH	40 1/4"	41 1/8"	36 3/4"
DEPTH	26 1/4"	27 1/4"	28 5/8"
HEIGHT	40 5/8"	43 5/8"	40 5/8"
WEIGHT	444 lb	511 lb	495 lb

CLEARANCES FROM UNIT TO COMBUSTIBLE MATERIALS

SIDE WALL	24"	24"	13"
BACK WALL	0"	0"	0"
SIDES	0"	0"	0"
FLOOR	0"	0"	0"
CEILING	84"	72"	80"
SHELF* (FROM BOTTOM OF FIREPLACE)	48"	48"	58"
SIDE MANTLE	6"	0"	8"
NON-COMBUSTIBLE SURROUND (TOP) FROM FACEPLATE	0"	5 1/2"	To the ceiling
NON-COMBUSTIBLE SURROUND (SIDES) FROM FACEPLATE	0"	0"	1 1/2"

*For installation of a 6" deep shelf. For other shelf dimensions, refer to the owner's manual.

WOOD FIREPLACES

HE275CF
 VB00017

HE325
 VB00018

HE350
 VB00005

FEATURES

COLOR	Black	Black	Black
BURN TIME (ON LOW SETTING)	8 hours	9 hours	11 hours
COMBUSTION TECHNOLOGY	Non-catalytic	Non-catalytic	Non-catalytic
HEATING CAPACITY - BTU/h, EPA TEST LOAD	60,700	49,654	43,000
HEATING CAPACITY - BTU/h, SEASONED CORD WOOD	80,000	85,000	95,000
EMISSIONS (EPA)	1.2 g/h	0.99 g/h	1.6 g/h
OPTIMUM EFFICIENCY	70 %	72 %	70 %
DOOR OPENING DIMENSIONS (W X H)	25 3/8" x 10 1/2"	20 3/4" x 10 1/4"	33" x 12 3/4"
FIREBOX DIMENSIONS (W X D) BEHIND ANDIRON	20 3/4" x 12 7/8"	18 7/8" x 17"	25 3/8" x 17 7/8"
GLASS VIEWING AREA (W X H)	24" x 10 5/8"	18 3/4" x 11"	29 3/4" x 13 1/2"
DOOR TYPE	Single, glass with cast iron frame	Double, glass with cast iron frame	Double, glass with cast iron frame
MAXIMUM LOG LENGTH	20"	18"	25"
RECOMMENDED LOG LENGTH	16"	16"	16"
LOG POSITIONING	Over width	Over width	Over width
CHIMNEY DIAMETER (INNER)	6"	6"	8"
MINIMUM CHIMNEY HEIGHT (FROM BASE OF FIREPLACE)	15'	15'	15'
GLASS TYPE	Ceramic glass	Ceramic glass	Ceramic glass
WARRANTY	Limited lifetime	Limited lifetime	Limited lifetime
TEST STANDARD - EMISSIONS/EFFICIENCY	EPA / CSA B415.1-10	EPA / CSA B415.1-10	EPA / CSA B415.1-10
TEST STANDARD - SAFETY	ULC-S610 / UL 127	ULC-S610 / UL 127	ULC-S610 / UL 127

EXTERIOR DIMENSIONS AND WEIGHT

WIDTH	50 1/4"	41 3/4"	50 3/4"
DEPTH	27 1/4"	28 7/8"	31 3/4"
HEIGHT	40 5/8"	49 1/8"	43 3/8"
WEIGHT	495 lb	530 lb	555 lb

CLEARANCES FROM UNIT TO COMBUSTIBLE MATERIALS

SIDE WALL	13"	21"	24"
BACK WALL	0"	0"	0"
SIDES	0"	0"	0"
FLOOR	0"	0"	0"
CEILING	76"	80"	84"
SHELF* (FROM BOTTOM OF FIREPLACE)	48"	48" **	52" **
SIDE MANTLE	8"	8"	8"
NON-COMBUSTIBLE SURROUND (TOP) FROM FACEPLATE	To the ceiling	To the ceiling	To the ceiling
NON-COMBUSTIBLE SURROUND (SIDES) FROM FACEPLATE	8"	4"	3 1/16"

*For installation of a 6" deep shelf. For other shelf dimensions, refer to the owner's manual. **Non-combustible shelf only.



CHIMNEY

MANUFACTURER

Olympia Chimney of Canada

BRAND

Ventis

TYPE

1" Solid Pack

ME150

VB00004

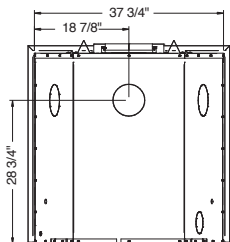
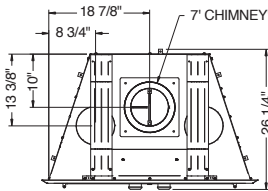
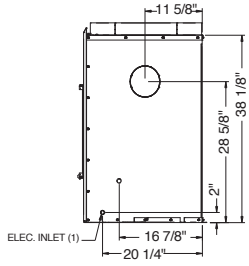
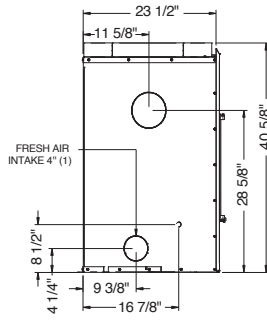
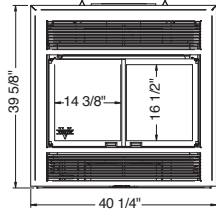

ME300

VB00001

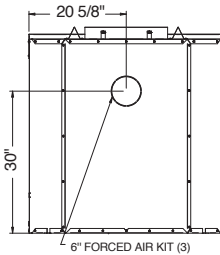
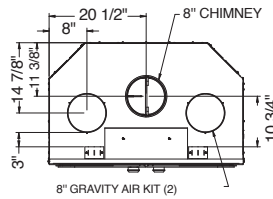
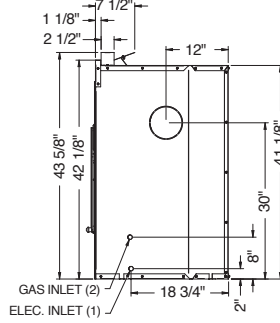
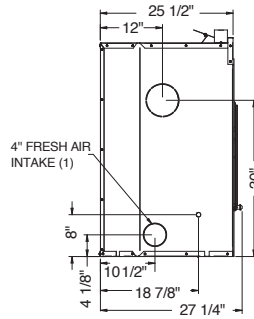
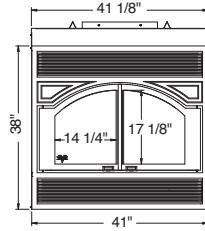

HE250R

VB00015

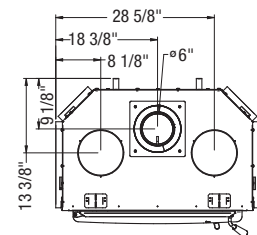
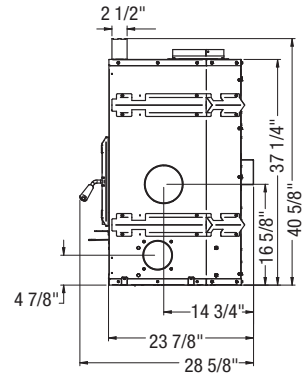
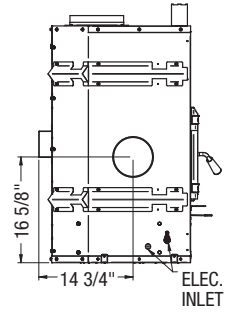
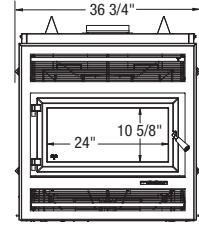

HE275CF
VB00017

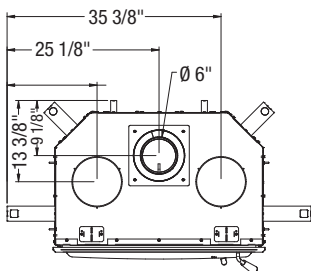
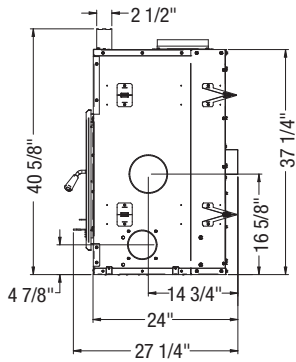
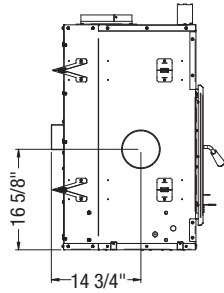
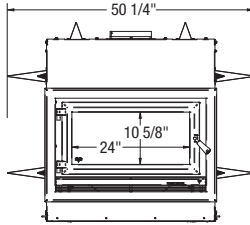

HE325
VB00018

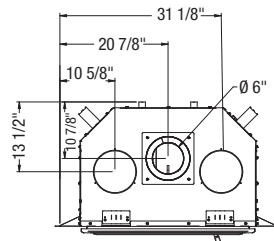
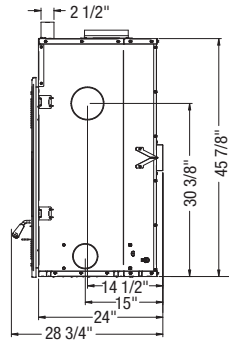
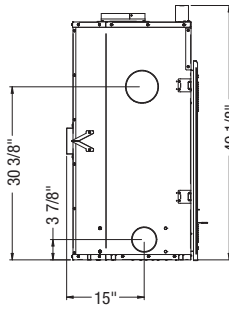
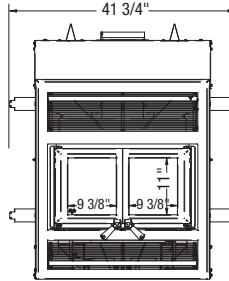

HE350
VB00005

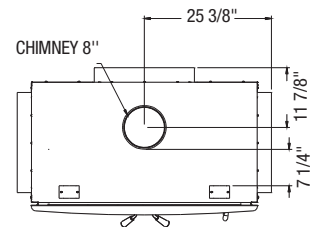
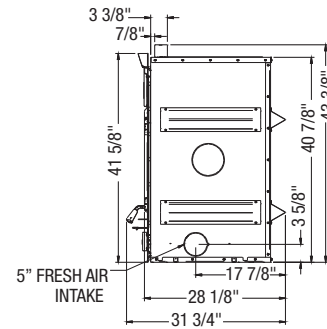
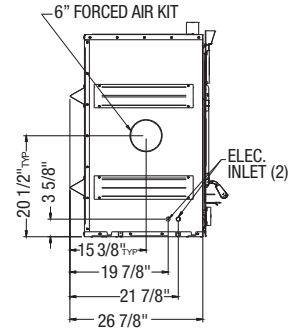
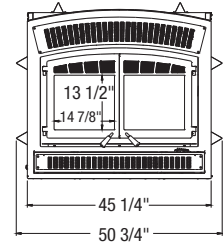

WOOD STOVES

HES140

VB00023



HES170

VB00013



FEATURES

COLOR	Black	Black
MAXIMUM BURN TIME ¹	5 hours	7 hours
COMBUSTION TECHNOLOGY	Non-catalytic	Non-catalytic
RECOMMENDED HEATING AREA ¹	250 - 1,200 ft ²	500 - 1,800 ft ²
HEATING CAPACITY - BTU/H, EPA TEST LOAD	26,700 BTU/h	52,200 BTU/h
HEATING CAPACITY - BTU/H, SEASONED CORD WOOD	45,000 BTU/h	65,000 BTU/h
AVERAGE PARTICULATE EMISSIONS RATE	1.8 g/h	2.4 g/h
OPTIMUM EFFICIENCY	80%	76%
DOOR OPENING DIMENSIONS (W X H)	12" x 7 5/8"	17 1/4" x 8"
FIREBOX DIMENSIONS (W X D)	14 1/4" x 19 1/8"	19 5/8" x 13 1/2"
FIREBOX VOLUME	1.8 ft ³	1.86 ft ³
GLASS VIEWING AREA (W X H)	10 1/8" x 8 1/4"	15 5/8" x 9 1/4"
DOOR TYPE	Single, glass with cast iron frame	Single, glass with cast iron frame
MAXIMUM LOG LENGTH	17"	18"
RECOMMENDED LOG LENGTH	16"	16"
LOG POSITIONING	Over length	Over width
FLUE SPIGOT DIAMETER	6"	6"
GLASS TYPE	Ceramic glass	Ceramic glass
ASH DRAWER WITH SAFETY LID	No	Yes
MOBILE HOME APPROVED ²	Yes	Yes
APPROVED FOR AN ALCOVE INSTALLATION	Yes	Yes
WARRANTY	Limited lifetime	Limited lifetime
TEST STANDARD - EMISSIONS/EFFICIENCY	EPA / CSA B415.1-10	EPA / CSA B415.1-10
TEST STANDARD - SAFETY	ULC S627, UL 1482, UL 737, NFPA 211, CSA B365 standards applicable in Canada and USA	

EXTERIOR DIMENSIONS AND WEIGHT

WIDTH	20"	24 7/8"
DEPTH	29"	22 3/4"
HEIGHT	30 1/4"	29 1/2"
WEIGHT	300 lb	330 lb

CLEARANCES FROM UNIT TO COMBUSTIBLE MATERIALS (FIGURES 1, 2, 3, SEE PAGE 29)

WITH SINGLE WALL PIPE³	(Canada / USA)	(Canada / USA)
A- BACK	14"/12"	14 1/2"/13"
B- SIDES	12"/12"	10"/10"
C - CORNERS	11"/11"	12"/12"
D - CEILING ⁴	84"/84"	84"/84"
WITH DOUBLE WALL PIPE	(Canada / USA)	(Canada / USA)
A- BACK	6"/6"	7 1/2"/7 1/2"
B- SIDES	12"/12"	10"/10"
C - CORNERS	6"/6"	12"/12"
D - CEILING ⁴	84"/84"	84"/84"
MINIMUM FLOOR PROTECTION IN FRONT OF UNIT	18"/16"	18"/16"

HES240
VB00016



HES350
VB00020



Black	Black
8 hours	10 hours
Non-catalytic	Non-catalytic
500 - 2,100 ft ²	1,000 - 2,700 ft ²
28,600 BTU/h	49,500 BTU/h
75,000 BTU/h	110,000 BTU/h
2.3 g/h	1.6 g/h
79%	77%
17 1/2" x 9"	19" x 9 1/4"
21" x 17 1/8"	22 7/8" x 20 1/8"
2.4 ft ³	3.5 ft ³
16 7/8" x 10 1/4"	18 3/8" x 11 1/2"
Single, glass with cast iron frame	Single, glass with cast iron frame
20"	22"
16"	16"
Over width	Over width
6"	6"
Ceramic glass	Ceramic glass
Yes	Yes
Yes	Yes
Yes	Yes
Limited lifetime	Limited lifetime
EPA / CSA B415.1-10	EPA / CSA B415.1-10
ULC S627, UL 1482, UL 737, NFPA 211, CSA B365 standards applicable in Canada and USA	

26 3/4"	28 3/4"
26 3/4"	30 5/8"
32 1/8"	34 3/4"
375 lb	485 lb

(Canada / USA)	(Canada / USA)
14 1/2"/11"	13 1/4"/13"
17"/16"	14"/14"
10"/10"	7 1/4"/7 1/4"
84"/84"	84"/84"
(Canada / USA)	(Canada / USA)
6"/6"	7"/7"
17"/16"	14"/14"
7"/7"	7"/7"
84"/84"	84"/84"
18"/16"	18"/16"

Figure 1

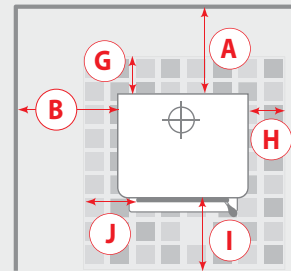

Figure 2

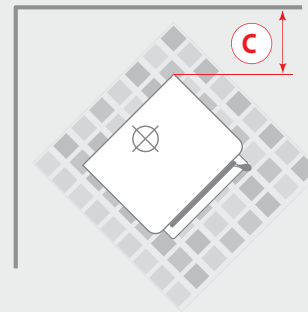
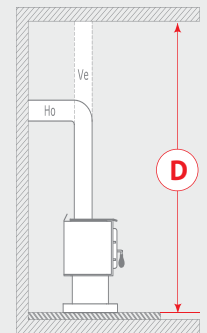

Figure 3



FLOOR PROTECTOR †		
	CANADA	USA
G	8" – Note ‡	N/A (Canada only)
H	8"	N/A (Canada only)
I	18" From door opening	16" From door opening
J	N/A (USA only)	8" From door opening

† Steel with a minimum thickness of 0.015" (0.38 mm) or ceramic tiles sealed together with grout.

No protection is required if the unit is installed on a non-combustible floor (ex: concrete).

‡ The floor protection at the back of the stove is limited to the stove's required clearance if such clearance is smaller than 8 inches (203 mm).

- 1 Recommended heating area and maximum burn time may vary subject to location in home, chimney draft, heat loss factors, climate, fuel type and other variables. The recommended heated area for a given appliance is defined by the manufacturer as its capacity to maintain a minimum acceptable temperature in the designated area in case of a power failure.
- 2 Fresh air intake kit required.
- 3 Consult local code for minimum clearances of the single wall pipe itself to combustible materials. See also the venting manufacturer's instructions.
- 4 Measured from the base of the appliance. Some appliances have been tested with a low ceiling. Before setting up your unit, refer to the installation manual.

Technical data contained in this brochure are for reference only. Any installation must be done according to the data and drawings detailed in the owner's manual.

HES140

VB00023

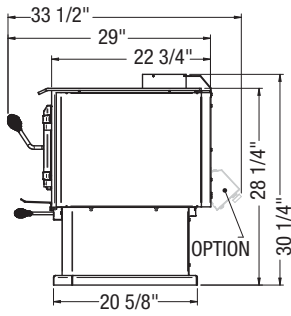
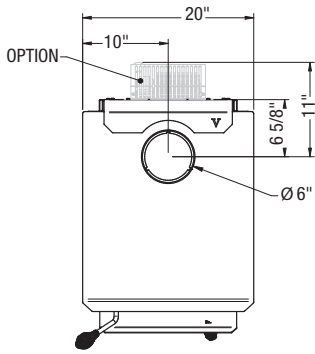
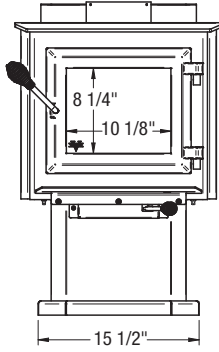

HES170

VB00013

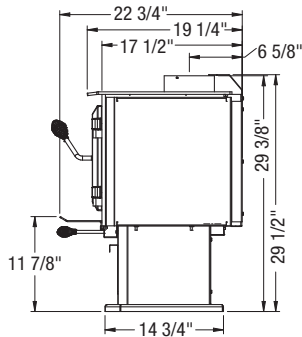
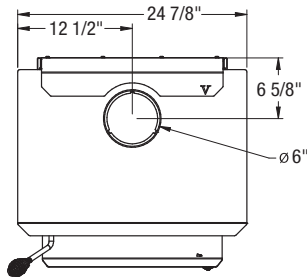
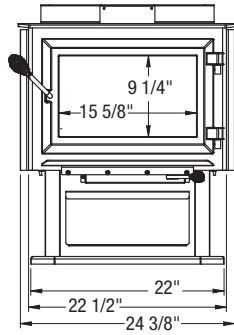

HES240

VB00016

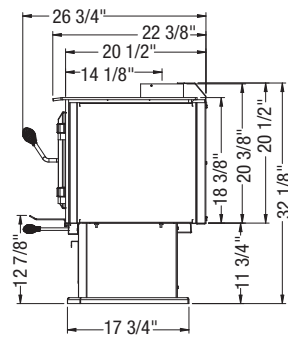
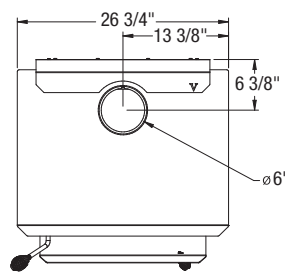
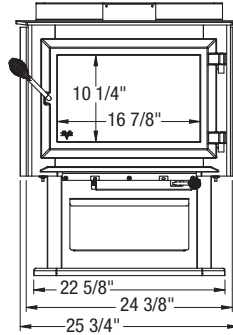

HES350

VB00020

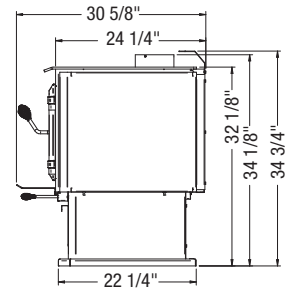
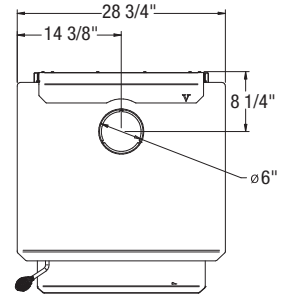
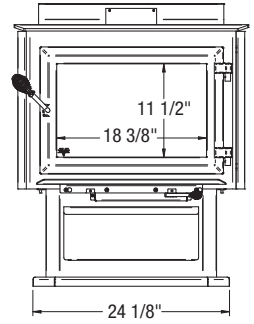

WOOD INSERTS

HEI90

VB00024



HEI170

VB00014



FEATURES

COLOR	Black	Black
MAXIMUM BURN TIME ¹	7 hours	7 hours
COMBUSTION TECHNOLOGY	Non-catalytic	Non-catalytic
RECOMMENDED HEATING AREA ¹	250 - 1,200 ft ²	500 - 1,800 ft ²
HEATING CAPACITY - BTU/h, EPA TEST LOAD	52,200 BTU/h	52,200 BTU/h
HEATING CAPACITY - BTU/h, SEASONED CORD WOOD	45,000 BTU/h	65,000 BTU/h
AVERAGE PARTICULATE EMISSIONS RATE	1.5 g/h	2.4 g/h
OPTIMUM EFFICIENCY	82%	76%
DOOR OPENING DIMENSIONS (W X H)	18 1/4" x 7 7/8"	17 1/4" x 8 3/4"
FIREBOX DIMENSIONS (W X D)	16 3/4" x 12 3/8"	19 5/8" x 13 1/2"
FIREBOX VOLUME	1.1 ft ³	1.86 ft ³
GLASS VIEWING AREA (W X H)	17 7/8" x 8"	15 5/8" x 9 1/4"
DOOR TYPE	Single, glass with cast iron frame	Single, glass with cast iron frame
MAXIMUM LOG LENGTH	17"	18"
RECOMMENDED LOG LENGTH	16"	16"
LOG POSITIONING	Over width	Over width
FLUE SPIGOT DIAMETER	6"	6"
GLASS TYPE	Ceramic glass	Ceramic glass
WARRANTY	Limited lifetime	Limited lifetime
TEST STANDARD - EMISSIONS/EFFICIENCY	EPA / CSA B415.1-10	EPA / CSA B415.1-10
TEST STANDARD - SAFETY	ULC S628, UL 1482, UL 737, NFPA 211, CSA B365 standards applicable in Canada and USA	

EXTERIOR DIMENSIONS AND WEIGHT

WIDTH (WITHOUT FACEPLATE)	27 7/8"	27 1/8"
DEPTH	20"	22 3/8"
HEIGHT (WITHOUT FACEPLATE)	20 1/8"	21"
WEIGHT	282 lb	350 lb

CLEARANCES FROM UNIT TO COMBUSTIBLE MATERIALS (FIGURE 1, SEE PAGE 32)

A- ADJACENT SIDEWALL	16"	16"
B- COMBUSTIBLE SIDE SURROUND	1"	9"
C - COMBUSTIBLE TOP SURROUND	1"	27"
D - COMBUSTIBLE MANTLE SHELF DIMENSION (MAX)	12"	12"
E - MINIMUM CLEARANCE FROM A COMBUSTIBLE MANTLE SHELF	34"	27"
F, G, H - MINIMUM FIREPLACE OPENING WITH BLOWER (H X W X D)	19" x 25" x 15 1/2"	21 1/2" x 27 1/2" x 12 3/4"
I - MINIMUM FLOOR PROTECTION IN FRONT OF UNIT (CAN/USA)	18"/16"	18"/16"

¹ Recommended heating area and maximum burn time may vary subject to location in home, chimney draft, heat loss factors, climate, fuel type and other variables. The recommended heated area for a given appliance is defined by the manufacturer as its capacity to maintain a minimum acceptable temperature considering the configuration of the space or the presence of an air distribution system have a significant impact on the optimal distribution of heat.

WOOD INSERTS

HEI240

VB00012



HEI350

VB00021



FEATURES

COLOR	Black	Black
MAXIMUM BURN TIME ¹	8 hours	10 hours
COMBUSTION TECHNOLOGY	Non-catalytic	Non-catalytic
RECOMMENDED HEATING AREA ¹	500 - 2,100 ft ²	1,000 - 2,700 ft ²
HEATING CAPACITY - BTU/h, EPA TEST LOAD	28,600 BTU/h	49,500 BTU/h
HEATING CAPACITY - BTU/h, SEASONED CORD WOOD	75,000 BTU/h	110,000 BTU/h
AVERAGE PARTICULATE EMISSIONS RATE	2.3 g/h	1.6 g/h
OPTIMUM EFFICIENCY	79%	77%
DOOR OPENING DIMENSIONS (W X H)	17 1/2" x 9"	19" x 9 1/4"
FIREBOX DIMENSIONS (W X D)	21" x 16 3/4"	22 7/8" x 20 1/8"
FIREBOX VOLUME	2.4 ft ³	3.5 pi ³
GLASS VIEWING AREA (W X H)	16 7/8" x 10 1/4"	18 3/8" x 11 1/2"
DOOR TYPE	Single, glass with cast iron frame	Single, glass with cast iron frame
MAXIMUM LOG LENGTH	20"	22"
RECOMMENDED LOG LENGTH	16"	16"
LOG POSITIONING	Over width	Over width
FLUE SPIGOT DIAMETER	6"	6"
GLASS TYPE	Ceramic glass	Ceramic glass
WARRANTY	Limited lifetime	Limited lifetime
TEST STANDARD - EMISSIONS/EFFICIENCY	EPA / CSA B415.1-10	EPA / CSA B415.1-10
TEST STANDARD - SAFETY	ULC S628, UL 1482, UL 737, NFPA 211, CSA B365 standards applicable in Canada and USA	

EXTERIOR DIMENSIONS AND WEIGHT

WIDTH (WITHOUT FACEPLATE)	28 1/2"	30 1/2"
DEPTH	26 3/4"	29"
HEIGHT (WITHOUT FACEPLATE)	22 7/8"	24 7/8"
WEIGHT	400 lb	540 lb

CLEARANCES FROM UNIT TO COMBUSTIBLE MATERIALS (FIGURE 1)

A- ADJACENT SIDEWALL	16"	19"
B- COMBUSTIBLE SIDE SURROUND	9"	9"
C - COMBUSTIBLE TOP SURROUND	27"	27"
D - COMBUSTIBLE MANTLE SHELF DIMENSION (MAX)	12"	12"
E - MINIMUM CLEARANCE FROM A COMBUSTIBLE MANTLE SHELF	27"	27"
F, G, H - MINIMUM FIREPLACE OPENING WITH BLOWER (H X W X D)	23 3/8" x 28 7/8" x 15 3/4"	26 1/4" x 31" x 18 3/8"
I - MINIMUM FLOOR PROTECTION IN FRONT OF UNIT (CAN/USA)	18"/16"	18"/16"

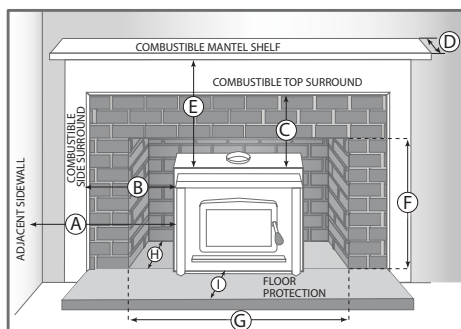
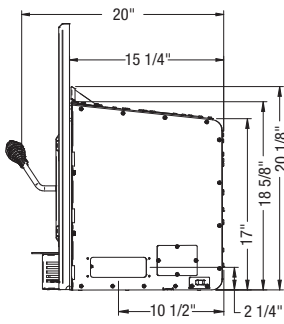
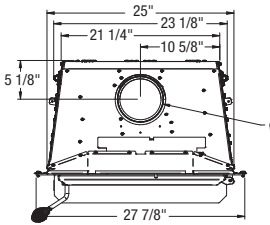
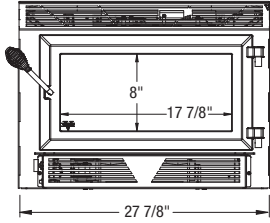

Figure 1

① From door opening

¹ Recommended heating area and maximum burn time may vary subject to location in home, chimney draft, heat loss factors, climate, fuel type and other variables. The recommended heated area for a given appliance is defined by the manufacturer as its capacity to maintain a minimum acceptable temperature considering the configuration of the space or the presence of an air distribution system have a significant impact on the optimal distribution of heat.

HEI90
VB000024



HEI170
VB000014

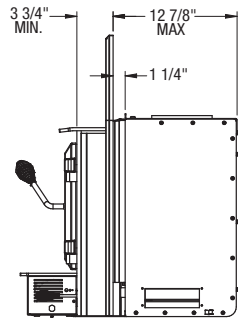
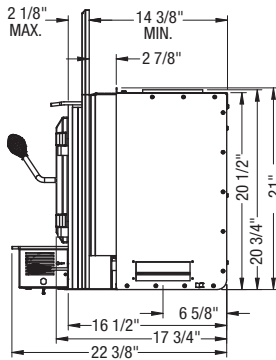
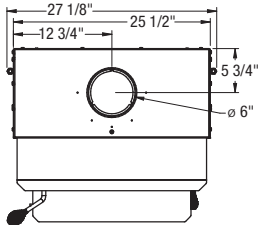
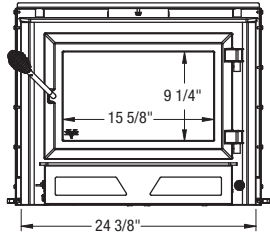

HEI240
VB000012

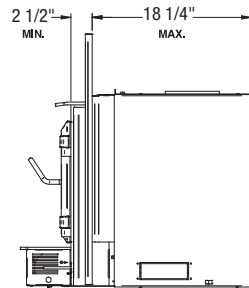
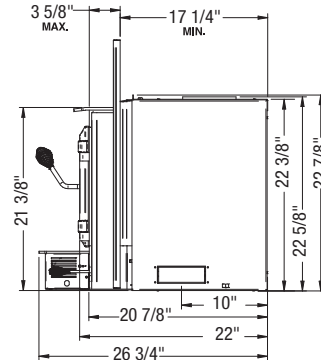
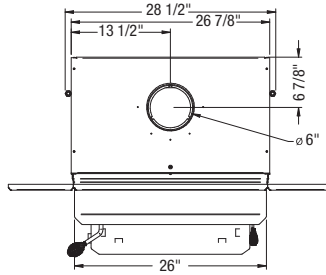
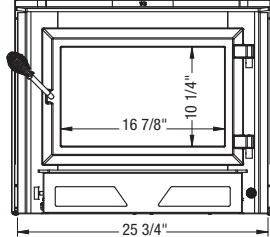

HEI350
VB000021

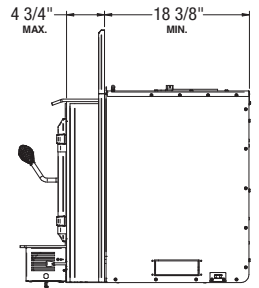
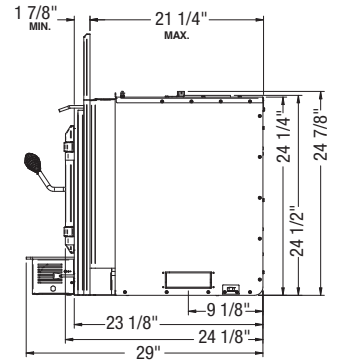
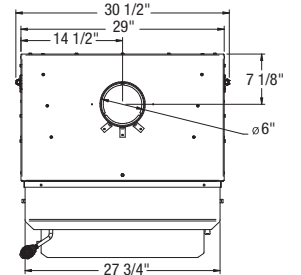
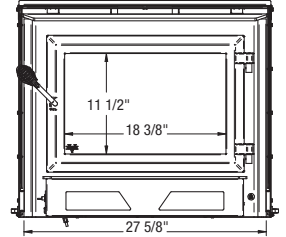

MAXIMUM RECOMMENDED HEATING AREA

IN SQUARE FEET BY CLIMATE ZONE

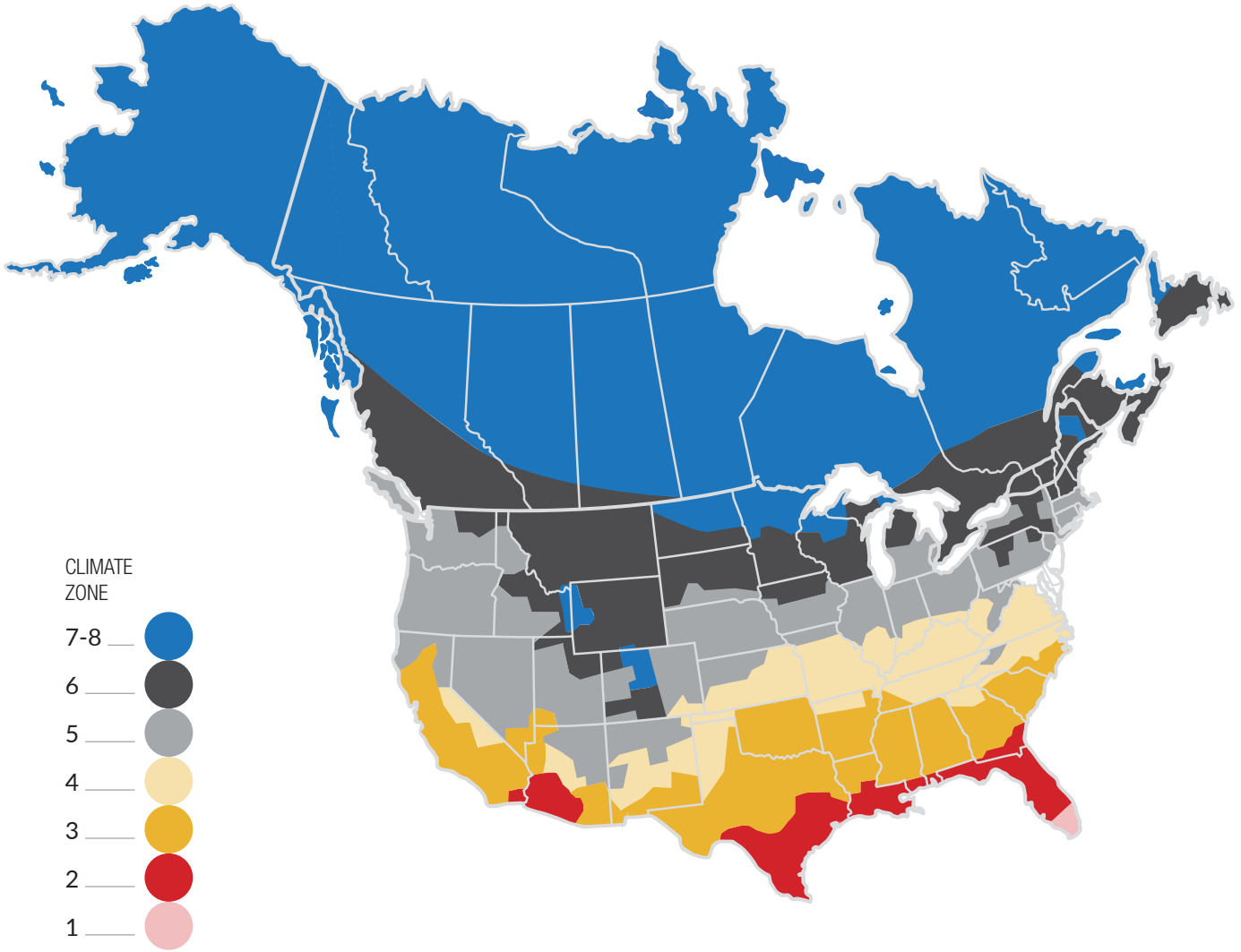

FIREPLACE MODELS	ZONE 1-2	ZONE 3	ZONE 4	ZONE 5	ZONE 6	ZONE 7-8
HE250R	3,000	2,800	2,600	2,400	2,200	1,800
HE275CF	3,000	2,800	2,600	2,400	2,200	1,800
HE325	3,300	3,100	2,900	2,700	2,500	2,100
HE350	3,600	3,400	3,200	3,000	2,800	2,400

WOOD STOVE MODELS	ZONE 1-2	ZONE 3	ZONE 4	ZONE 5	ZONE 6	ZONE 7-8
HES140	1,800	1,650	1,500	1,350	1,200	900
HES170	2,400	2,250	2,100	1,950	1,800	1,500
HES240	2,900	2,700	2,500	2,300	2,100	1,700
HES350	3,500	3,300	3,100	2,900	2,700	2,300

WOOD INSERT MODELS	ZONE 1-2	ZONE 3	ZONE 4	ZONE 5	ZONE 6	ZONE 7-8
HEI90	1,800	1,650	1,500	1,350	1,200	900
HEI170	2,400	2,250	2,100	1,950	1,800	1,500
HEI240	2,900	2,700	2,500	2,300	2,100	1,700
HEI350	3,500	3,300	3,100	2,900	2,700	2,300

EPA certified wood fireplaces generate a lot of heat. For the most part, they generate too much for the room where they are located. The heat distribution systems designed by Ventis allows you to redirect this heat to other areas in your home.

FORCED AIR KIT

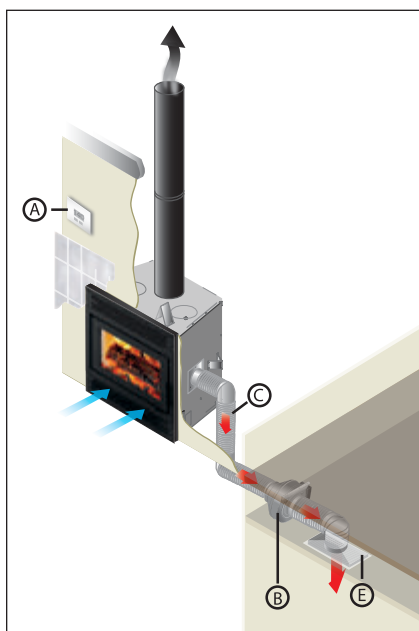
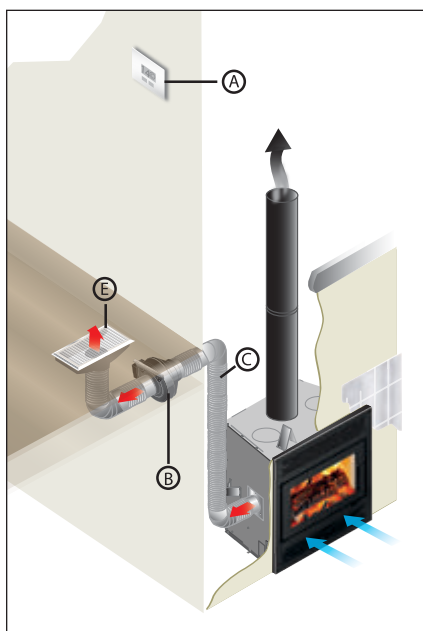

This system allows you to manage the heat distribution automatically.

Using a wall thermostat, you can select the temperature you want to maintain in the room where the fireplace is located. Once the thermostat is satisfied, the excess heat is redirected to another room up to 50 feet (15 m) away from the fireplace using a 300 CFM blower.

The system can also be used to supplement heat in a room remote from the fireplace. For this type of application, the thermostat needs to be positioned in the desired room and programmed with the temperature to be maintained. The system, now in "heat mode", will activate the blower as long as the temperature in the remote room is not achieved and that the fireplace has enough heat to distribute.

HOT AIR GRAVITY KIT

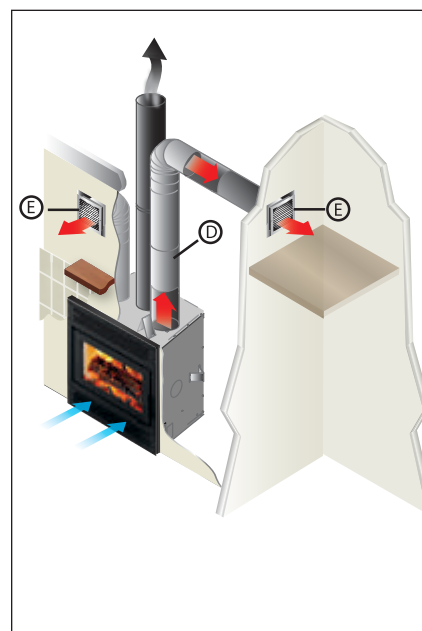

Ventis also offers you another way to circulate excess heat into your home with the help of a hot air gravity kit.

The hot air gravity kit allows you to bring hot air into the same room as the fireplace, in adjacent rooms, or up-stairs at a maximum distance of 10' (3 m).

(Not available for HE350).

Suggested installation: A) Wall thermostat B) 300 CFM blower C) Hot air flexible pipe D) Hot air rigid pipe E) Air register.

The information contained in this page is for reference purposes only. For more details about the content or installation requirements of the forced air kit or the hot air gravity kit, please refer to the owner's manuals.

HOW TO DIFFERENTIATE EACH **TYPE OF FIREPLACE**



Our EPA-certified wood fireplaces (HE250R, HE275CF, HE325 and HE350) have been tested and obtained emissions lower than the limit imposed by the EPA 2020 standard for wood heating appliances. Emissions are reported in grams per hour. As with an EPA certified wood stove, you will benefit from high efficiency combustion, in addition to being able to use your appliance in slow combustion mode overnight. Indeed, a control makes it possible to adjust the air supply to the fire, which allows you to obtain the burn rate that suits you.

This model is
EPA QUALIFIED
 Under the LOW MASS
 Wood-Burning Fireplace Program

PHASE 2
 EMISSION
 LEVEL

EPA-qualified wood fireplaces (ME300) have been tested for particulate emissions. This time, the results were below the limit proposed by Phase II of the voluntary program for wood-burning fireplaces implemented by the US EPA. Emissions are calculated in grams of particles emitted per kilogram of wood burned. Qualified fireplaces are used in the same way as conventional wood-burning fireplaces. However, these fireplaces are generally better insulated and more efficient than conventional ambiance fireplaces. They produce beautiful heat and allow you to have an exceptional view of the flames. They can be operated with the doors open or closed. However, having no control to adjust the burn rate, these fireplaces are not designed to burn overnight.

EPA exempt

Wood fireplaces (ME150) are designed for ambiance with the doors opened or closed. The combustion rate of this type of appliance is often very high and around 5 kg of wood per hour or more. These conventional fireplaces will provide warmth and an exceptional view of the fire, but are not designed to burn overnight.



OLYMPIA CHIMNEY
OF CANADA Inc.
"Your Partner in the Business"



Our commitment to quality manifests itself through the strength and quality of our products, which are covered by the best warranty in the industry.

Olympia's commitment to quality is conspicuous through its product line.

2100 INSULATED CHIMNEY

DOUBLE WALL BLACK STOVE PIPE

PELLET VENT

STAINLESS STEEL FLEX LINER

FOREVER RIGID LINER

Our full range of venting systems can be adapted to any type of installation and appliance.

Essential elements to complete your heater installation project, the solidity of the pipe and chimney will ensure the optimal performance of your stove or fireplace.

www.occanada.com





More efficient than ever, Ventis products represent a clean and sustainable alternative heating source, while providing the incomparable atmosphere of a wood fire.

COMBUSTION TECHNOLOGY

All Ventis appliances are non-catalytic and easy to use. Certified to the highest environmental standards, our heaters are among the cleanest in the industry.

LIMITED LIFETIME WARRANTY

Made in Canada, Ventis stoves and fireplaces represent performance and durability. Our limited lifetime warranty testifies to the robustness of our products and allows you to choose Ventis with confidence.

occanada.com

CONTACT US

Customer Service

Phone: 1 888 539-0864

possiblepurchase@sbi-international.com

Monday - Friday: 8 a.m. to 12 p.m. – 1 p.m. to 5 p.m. (EST)

Technical Support

Phone: 1 877 356-6663

tech@sbi-international.com

Monday - Friday: 8 a.m. to 12 p.m. – 1 p.m. to 5 p.m. (EST)



OLYMPIA CHIMNEY
OF CANADA Inc.
"Your Partner in the Business"



LYMPIA

CHEMINÉES OLYMPIA
DU CANADA Inc.
"Votre partenaire en affaires"

